



INSTALLATION INSTRUCTIONS AND OWNER'S MANUAL

RAVENWOOD



**LOG SET FOR UNVENTED
GAS LOG HEATER
OR
VENTED DECORATIVE APPLIANCE**

STANDARD MODELS

ALS18RV-1

ALS24RV-1

ALS30RV-1

SELECT MODELS

ALS24RVS-1

ALS30RVS-1

Installer: Leave this manual with the appliance.
Consumer: Retain this manual for future reference.

WARNING: If the information in these instructions are not followed exactly, a fire or explosion may result causing property damage, personal injury or loss of life.

- Do not store or use gasoline or other flammable vapors and liquids in the vicinity of this or any other appliance.
- **WHAT TO DO IF YOU SMELL GAS**
 - Do not try to light any appliance.
 - Do not touch any electrical switch; do not use any phone in your building.
 - Immediately call your gas supplier from a neighbor's phone. Follow the gas supplier's instructions.
 - If you cannot reach your gas supplier, call the fire department.
- Installation and service must be performed by a qualified installer, service agency or the gas supplier.

Log sets comply with ANSI Z21.11.2 Unvented Heaters and also comply with ANSI Z21.60 Decorative Vented Appliances for Solid Fuel Burning Fireplaces. State or local codes may only allow operation of log sets in a vented configuration. Check your state or local codes.

WARNING: If not installed, operated and maintained in accordance with the manufacturer's instructions, this product could expose you to substances in fuel or from fuel combustion which can cause death or serious illness.



TABLE OF CONTENTS

Section	Page
Important Installation Guidelines.....	3
General Information	3
Requirements for Canada.....	4
Log Identification - Standard Models	5
Log Placement - Standard Models.....	6-15
Log Identification - Select Models	16
Log Placement - Select Models	17-27
Ember Placement	28
Master Parts Distributor List.....	29
How To Order Repair Parts	29
Fireplace Service History	30-31

IMPORTANT INSTALLATION GUIDELINES

Proper Log Placement

Log placement is critical to proper burner performance. Logs must be correctly positioned onto the burner. The photos in this manual show the proper pinned position for logs on this set. Owners need to be shown proper log placement and instructed not to move the logs.

Logs must fit firmly onto the burner when positioned as shown in the photos. Malformed logs or logs with sloppy pin holes must be replaced.

Proper Placement of Rock Wool and Decorative Lava Rock

Rock wool can be added to burners for a glowing ember effect. It must be positioned only on the front portion of the burner. The photos in this manual show the proper placement of rock wool.

Decorative lava rock or small wood pieces should never be placed on the burner. These items are only for placement on the floor of the fireplace or firebox.

Proper Primary Airflow into Burner

For proper burner operation and flame appearance, the flow of primary air into the venturi tube, located on the rear of the burner, must not be reduced. This flow of air is reduced if dirt, lint or other obstructions build-up around or inside the venturi. Any obstruction in the venturi tube area must be removed. The flow of air into the venturi is also reduced if the gas orifice isn't centered in the venturi inlet and/or is not aligned with the venturi. Any misalignment of the burner orifice may be corrected by bending the shutter cap holding the orifice to the inlet of the venturi tube.

Ceiling Fans, Portable Fans or Logs Installed Near Cold Air Returns

Ceiling fans or oscillating floor type fans need to be monitored during the operation of vent-free logs. If the air blows directly into the flame causing it to impinge on the log set, or firebox, it should be turned off or redirected. Ceiling fans could be reversed to possibly eliminate flame impingement, and the floor fan could be redirected. Upon installation, be aware of any cold air returns or vents in the proximity of the log set.

Any draft created around a vent-free log set can cause the flame to impinge on the log and create a sooting situation.

WARNING: Do not allow fans to blow directly into the fireplace. Avoid any drafts that alter burner flame patterns.

WARNING: Do not use a blower insert, heat exchanger insert or other accessory not approved for use with this heater.

Candles

Avoid the use of scented or decorative candles while the log set is in operation. Candles produce a residue in the air that creates a soot like substance. Burning candles while the log set is operating magnifies the problem. It should be noted that candles, in general, produce soot. The amount of time burned and the quantity of candles burned will determine the amount of soot produced and deposited.

Make Owners Aware of Proper Log Set Operation

Properly installed and properly maintained log sets do not deposit soot on the logs. If users see soot appear on a log, call for service. Do not continue to operate the log set.

Sunken Fireplace

If installing this unit into a sunken fireplace, you must raise the floor to insure adequate airflow and guard against sooting. Raise fireplace floor using a non-combustible material, which is secure.

Glass Doors

Make sure that glass doors are open during all operations of the logset. The opening of the glass door frame should be the dimension used for the minimum front opening of the firebox.

Woodburning Fireplaces

The interior of the firebox and the chimney should be cleaned and free of all creosote before installing a gas burning log set. Creosote will soften when heated and can drop on the logset causing odors and possibly sooting.

WARNING: Before installing in a solid-fuel burning fireplace, the chimney flue and firebox must be cleaned of soot, creosote, ashes and loose paint by a qualified chimney cleaner.

GENERAL INFORMATION

Qualified Installing Agency

Installation and replacement of gas piping, gas utilization equipment or accessories and repair and servicing of equipment shall be performed only by a qualified agency. The term "qualified agency" means any individual, firm, corporation, or company that either in person or through a representative is engaged in and is responsible for (a) the installation, testing, or replacement of gas piping or (b) the connection, installation, testing, repair, or servicing of equipment; that is experienced in such work; that is familiar with all precautions required, and that has complied with all the requirements of the authority having jurisdiction.

The installation must conform with local codes or, in the absence of local codes, with the *National Fuel Gas Code, ANSI Z223.1/NFPA54*.
*Available from the American National Standards Institute, Inc. 11 West 42nd St., New York, N.Y. 10018.

State of Massachusetts: The installation must be made by a licensed plumber or gas fitter in the Commonwealth of Massachusetts.

Sellers of unvented propane or natural gas-fired supplemental room heaters shall provide to each purchaser a copy of 527 CMR 30 upon sale of the unit.

In the State of Massachusetts, unvented propane and natural gas-fired space heaters shall be prohibited in bedrooms and bathrooms.

REQUIREMENTS FOR CANADA

This unit **cannot** be installed in a UNVENTED application, this unit **can only** be installed as a VENTED application with these requirements.

IMPORTANT SAFETY INFORMATION

This unit complies with ANSI Z21.60 and CGA 2.26 Decorative Gas Appliances For Installation In Solid Fuel Burning Fireplaces. Do not burn wood or solid fuels in a fireplace where a decorative gas log set is installed. This appliance is for installation only in a solid fuel burning fireplace, masonry fireplace or manufactured fireplace.

Warning: Any modification to this gas log set or to controls can be dangerous. Improper installation or use of the gas log set can cause serious injury or death from fire, burns, explosion or carbon monoxide poisoning.

1. Please follow all local codes regarding installation, combustion and ventilation air or in the absence of local codes follow the National Fuel Gas Code ANSI Z223.1(U.S. installation), or CAN/CGA-B149, Installation Code (Canada installation).
2. Proper installation, burner pan location and log placement is important to achieve optimum look and performance of your gas log set. The logs have been designed for easy location and placement on the grate and must be followed for proper operation.
3. Do not operate this log set with glass doors in the closed position. A fireplace screen must be in place when the log set is burning. Adequate combustion air must be provided for proper venting. All flames should go up and out the top of the firebox into the flue vent. If any flames float or curl forward into the room do not operate appliance. Check for an open flue and adequate combustion air into the room. A damper clamp must be installed on the firebox damper to maintain an open flue vent condition. See fireplace instructions manual for installing damper clamp.
4. Young children must be carefully supervised when they are in the same room as the gas log while in operation. Do not place stockings, clothing or any flammable material above or near the fireplace.
5. Do not substitute or use materials other than those supplied for use with the log set.
6. Also refer to IMPORTANT SAFETY INFORMATION on page 3 of this manual

WARNING; DO NOT OPERATE THIS GAS LOG SET WITH GLASS DOORS CLOSED

- Clothing or other flammable material should not be placed on or near the appliance.
- Do not place trash or other articles on the log set during operation.
- During manufacturing, fabricating and shipping, various components of this appliance are treated with certain oils, films or bonding agents. These bonding agents are not harmful but may produce annoying smoke and smells as they are burned off during initial operation of the appliance. This is a normal temporary occurrence. A window should be opened during the initial bake out period.
- Keep burner and control compartment clean.
- **WARNING:** Before installing in a solid fuel burning fireplace, the chimney flue and firebox must be cleaned of soot, creosote, ashes and loose paint by a qualified chimney cleaner.
- Installation and repair should be done by a qualified service person. The appliance should be inspected before use and at least annually by a qualified service person. More frequent cleaning may be required due to excessive lint from carpeting, bedding materials, etc. It is imperative that control compartments, burners and circulating air passageways of the appliance be kept clean.
- **Do not** put anything around the fireplace that will obstruct the flow of ventilation air.
- **Do** keep the appliance area clear and free from combustible material, gasoline and other flammable vapors and liquids.
- A yearly examination and cleaning of the venting system of the solid-fuel burning fireplace must be performed by a qualified agency.
- **Do** make a periodic visual check of pilot and burners. Clean and replace damaged parts.
- **Do not** use this appliance if any part has been under water. Immediately call a qualified service technician to inspect the appliance and to replace any part of the control system and any gas control which has been under water.
- Never burn solid fuels in fireplace where a gas log set is installed.
- This unit complies with ANSI Z21.60 Decorative Vented Appliances for Solid Fuel Burning Fireplaces. State or local codes may only allow operation of this appliance in a vented configuration. Check your state or local codes.

LOG IDENTIFICATION - STANDARD MODELS

Log Description	Part Number			Front View	Top View
	ALS18RV	ALS24RV	ALS30RV		
Log A	R11864	R11872	R11877		
Log B	R11865	R11870	R11875		
Log C	R11866	R11871	R11876		
Log D	R11867	R11869	R11874		
Log E	R11879	R11879	R11879		
Log F	R11880	R11880	R11880		
Log G	R11884	R11881	R11884		
Log H	R11878	R11878	R11889		

Note: Logs are not shown to scale.

Note: Logs may differ from those shown.

USE ONLY MANUFACTURER'S REPLACEMENT PARTS. USE OF ANY OTHER PARTS COULD CAUSE INJURY OR DEATH.

LOG PLACEMENT - STANDARD MODELS

Before you begin: Do not, handle these logs with your bare hands! Always wear gloves to prevent skin irritation. After handling logs, wash your hands gently with soap and water.

All Logs

The positioning of the logs is critical to the safe and clean operation of this heater. Sooting and other problems may result if the logs are not properly and firmly positioned in the appliance.

Refer to Figure 1 for the following warning.

⚠ WARNING

Failure to position the parts in accordance with this diagram or failure to use only parts specifically approved with this appliance may result in property damage or personal injury.

Attention: Do not use Figures 1 to order replacement logs. Refer to Page 5, Log Identification-Standard Models, to order logs for your appropriate model number.

The following WARNING applies when log set is installed onto an unvented gas burner assembly.

⚠ WARNING

This appliance is equipped for (natural or propane) gas. Field conversion is not permitted.

Log Placement Standard Models

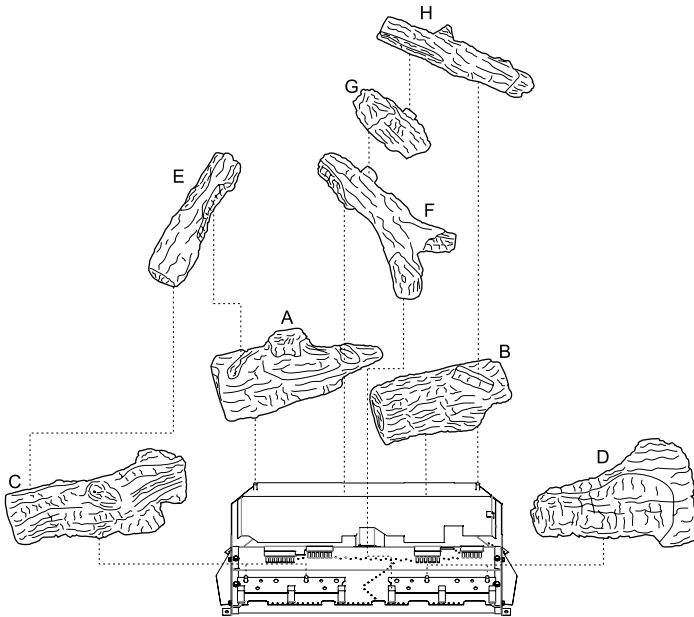
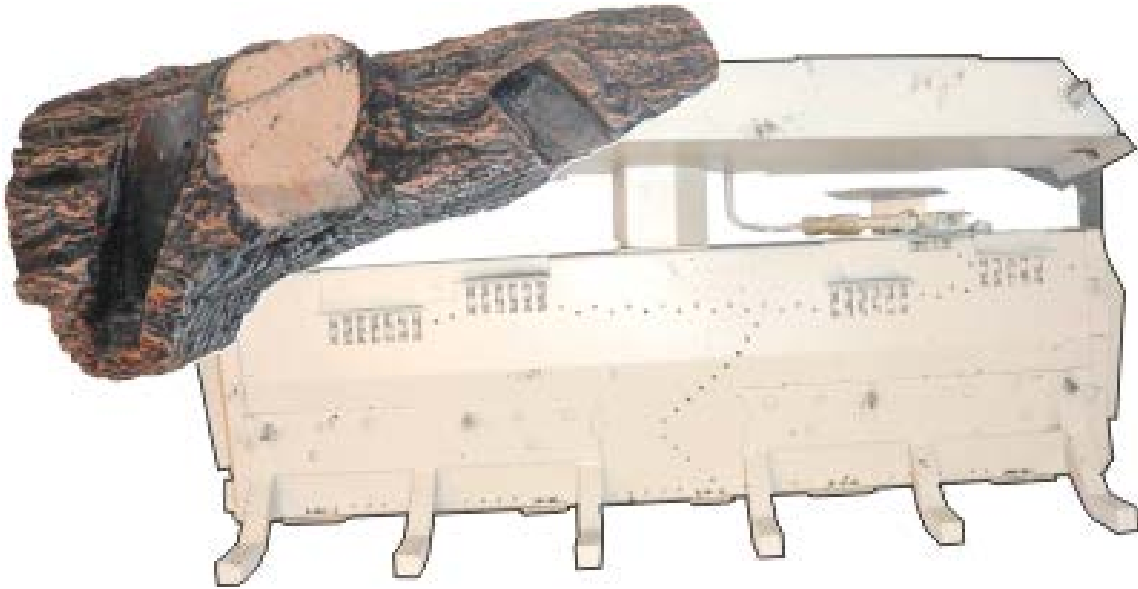

Figure 1

LOG PLACEMENT - STANDARD MODELS

1. Place Log A onto rear left burner pin as shown below.



TOP VIEW

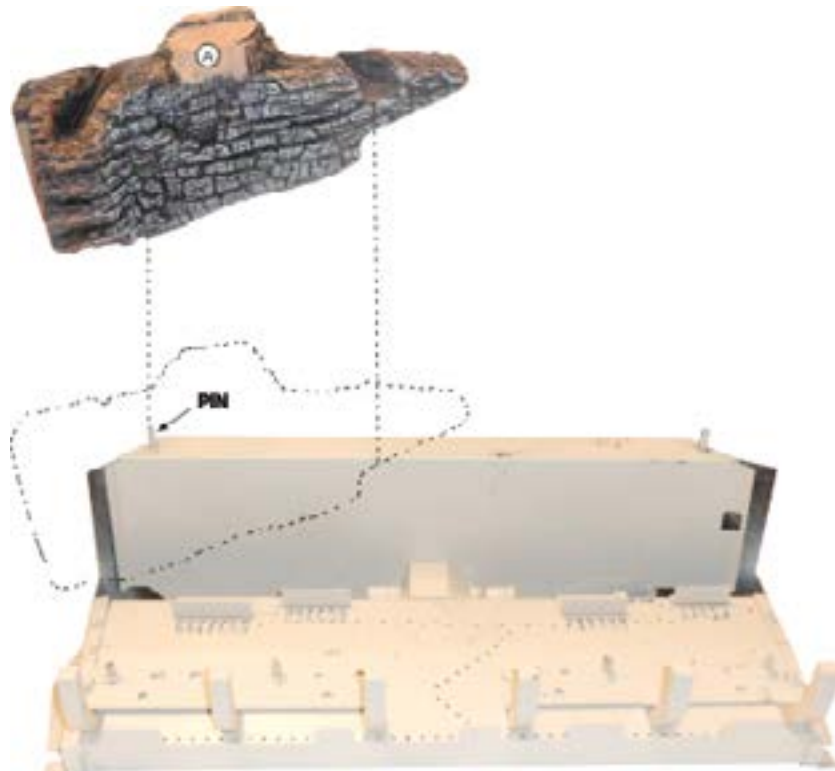

FRONT VIEW

LOG PLACEMENT - STANDARD MODELS

2. Place Log B onto right rear burner pin as shown below.

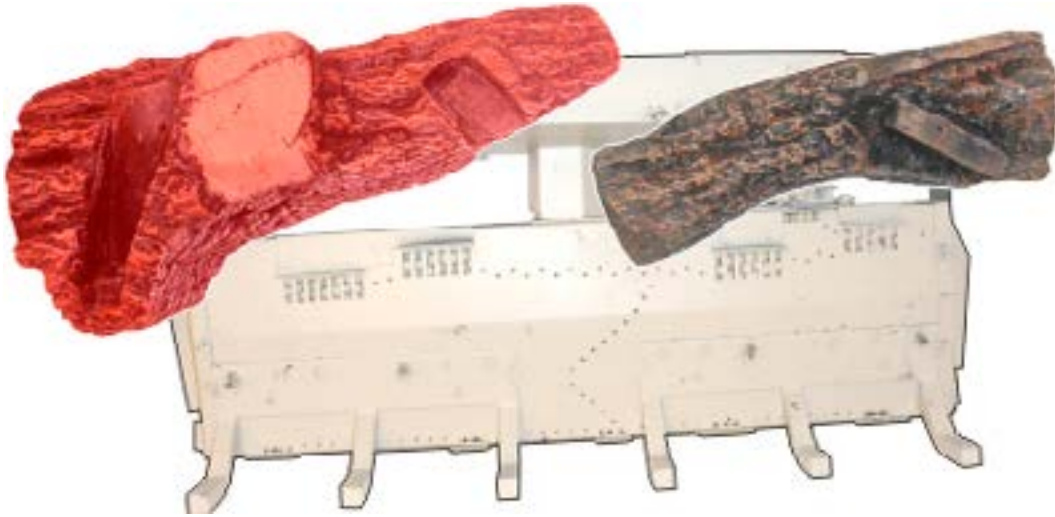

TOP VIEW

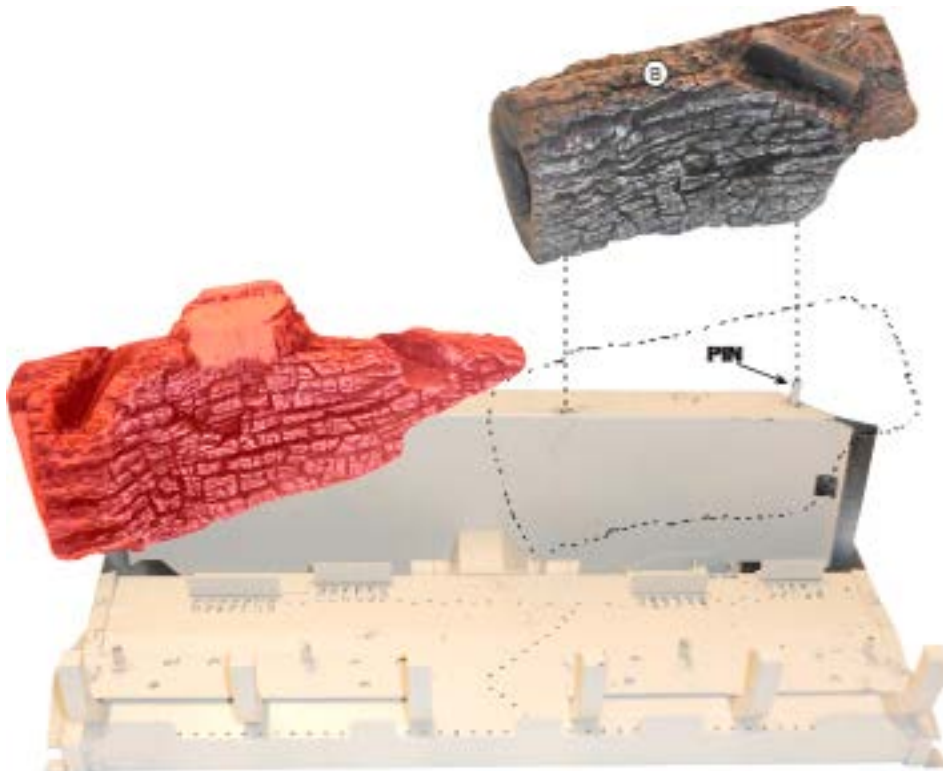

FRONT VIEW

LOG PLACEMENT - STANDARD MODELS

3. Place boss of Log C into the hole in Log B and onto the front two left burner pins. See image below.

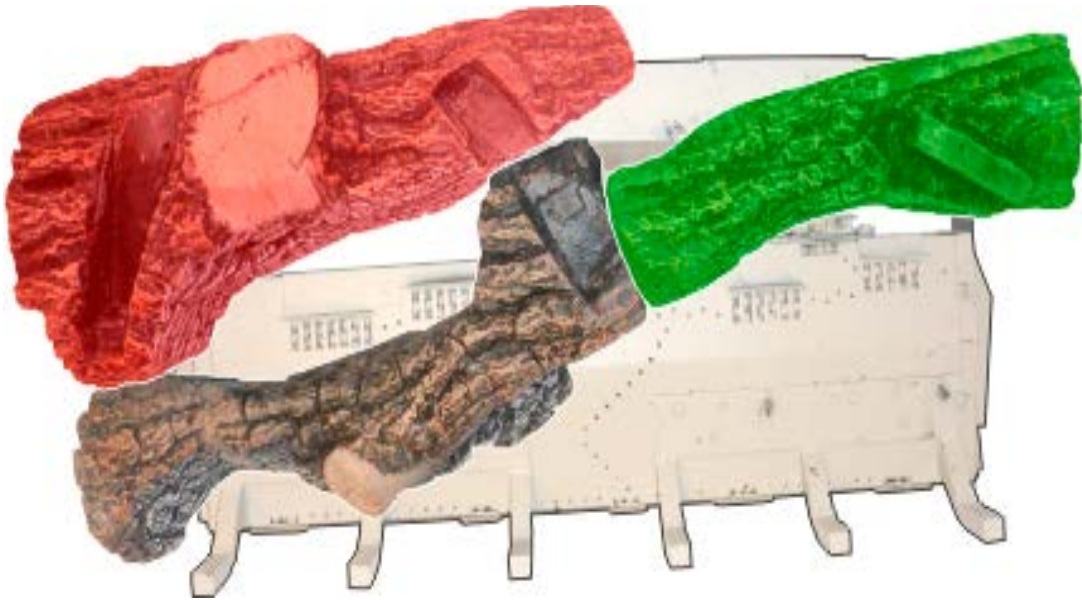

TOP VIEW

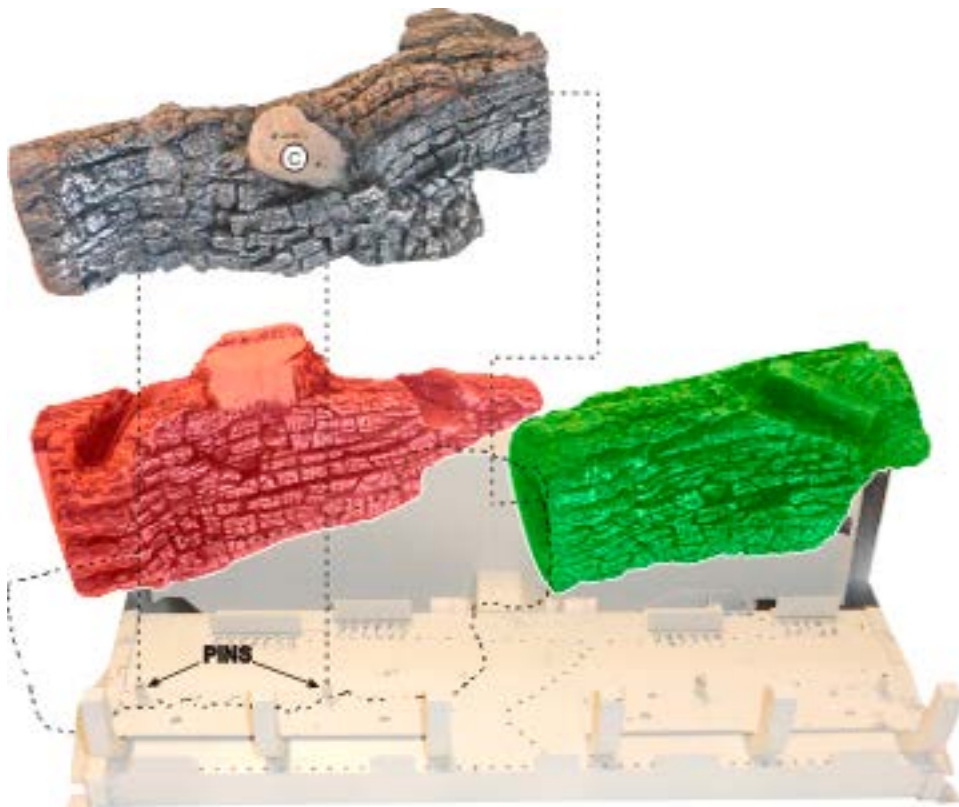

FRONT VIEW

LOG PLACEMENT - STANDARD MODELS

- Place Log D onto the front two right burner pins as shown below.

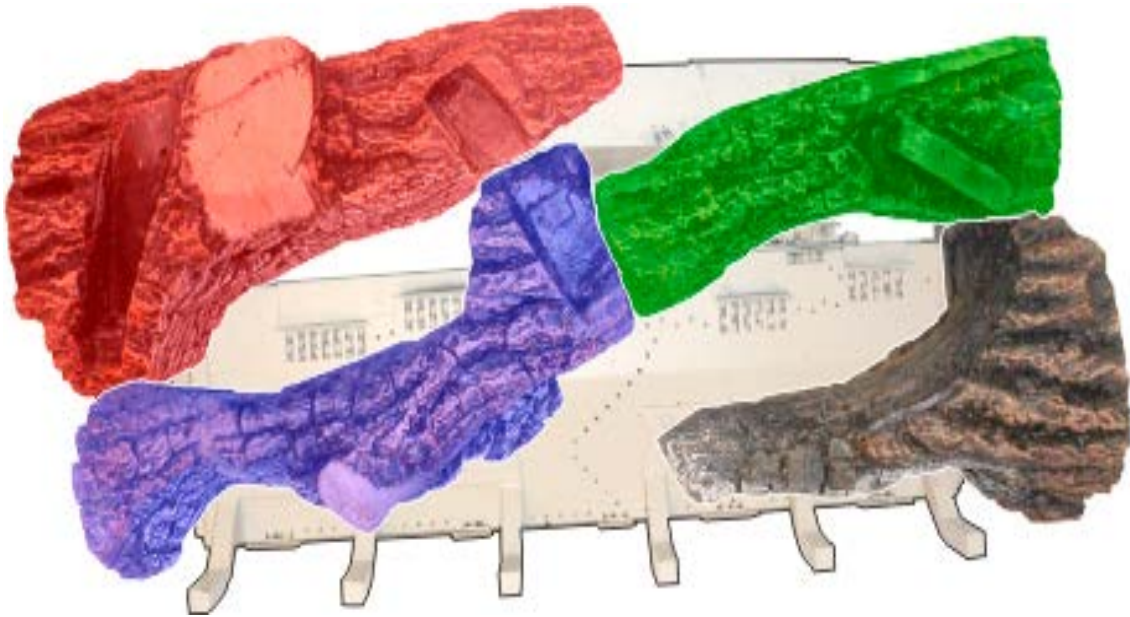

TOP VIEW

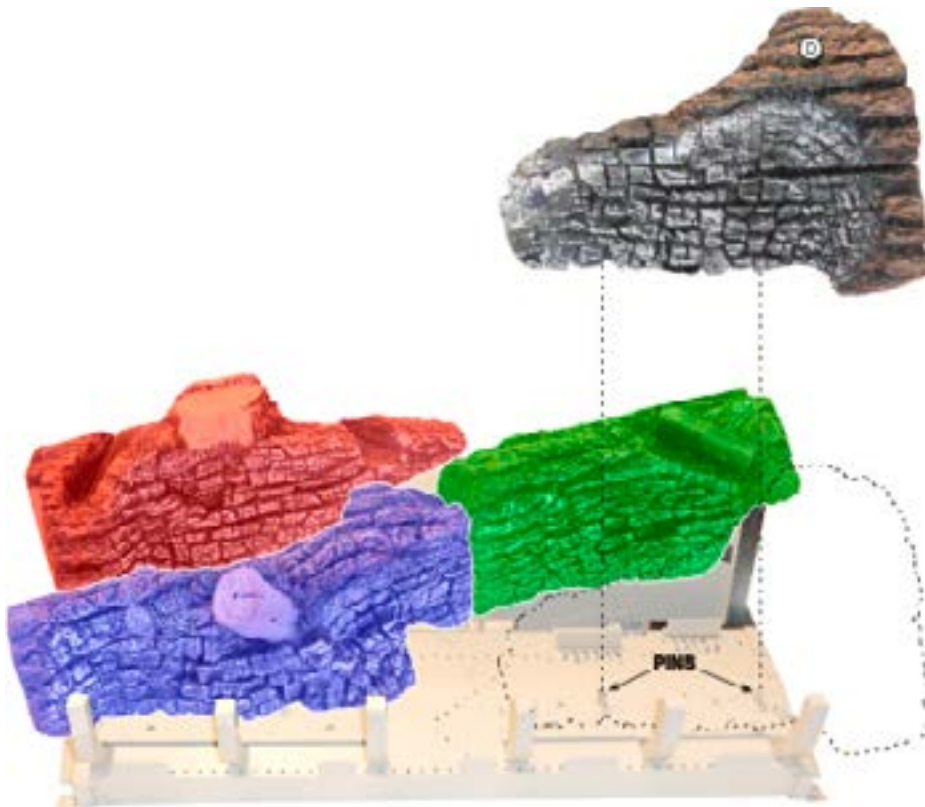

FRONT VIEW

LOG PLACEMENT - STANDARD MODELS

5. Place Log E into the left slot in Log A as shown below.

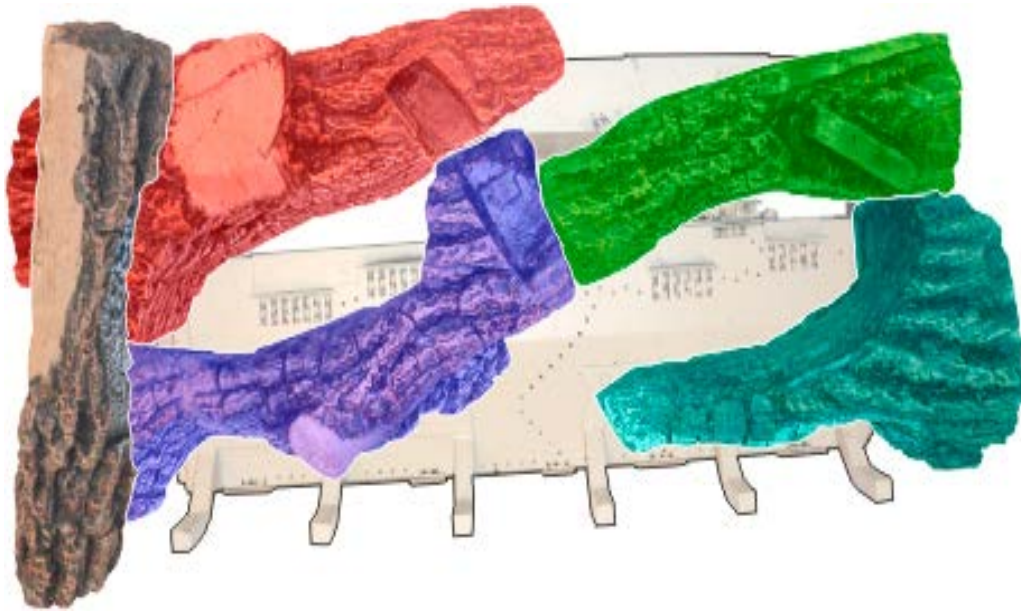

TOP VIEW



FRONT VIEW

LOG PLACEMENT - STANDARD MODELS

6. Place Log F into slot created by Log A and Log C. See image below.

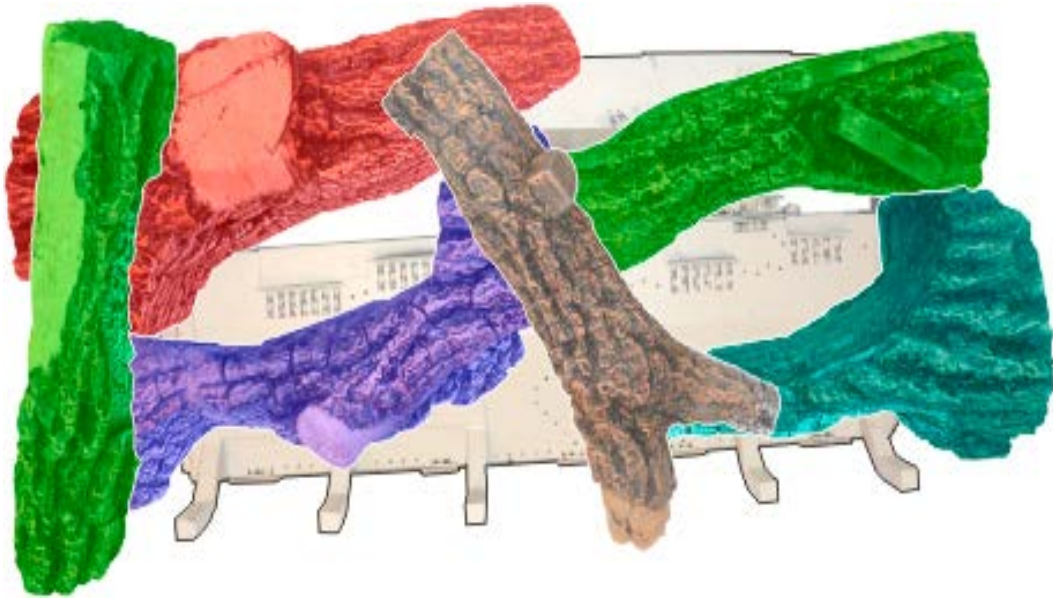

TOP VIEW

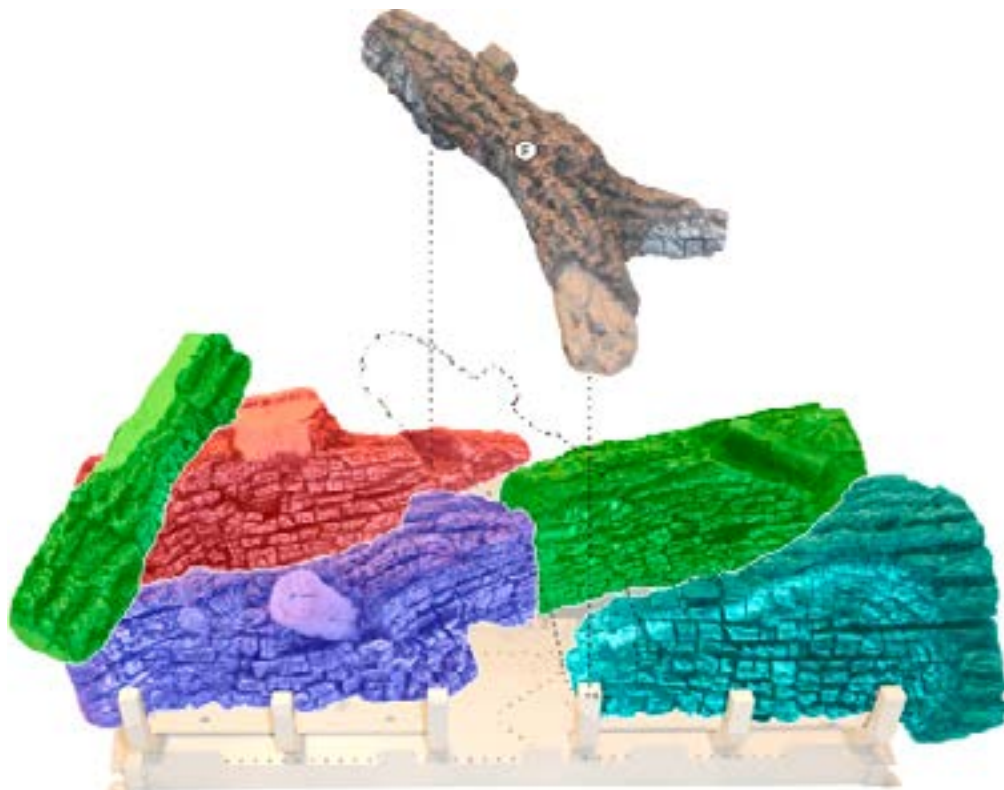

FRONT VIEW

LOG PLACEMENT - STANDARD MODELS

7. Place Log G onto boss on Log F and rest on log shelf as shown below.

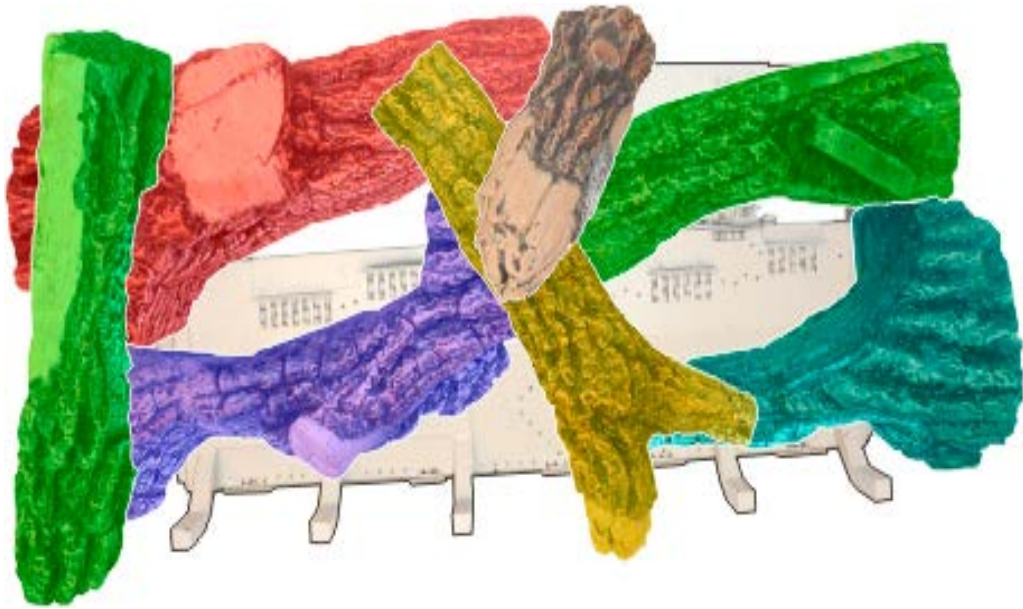

TOP VIEW

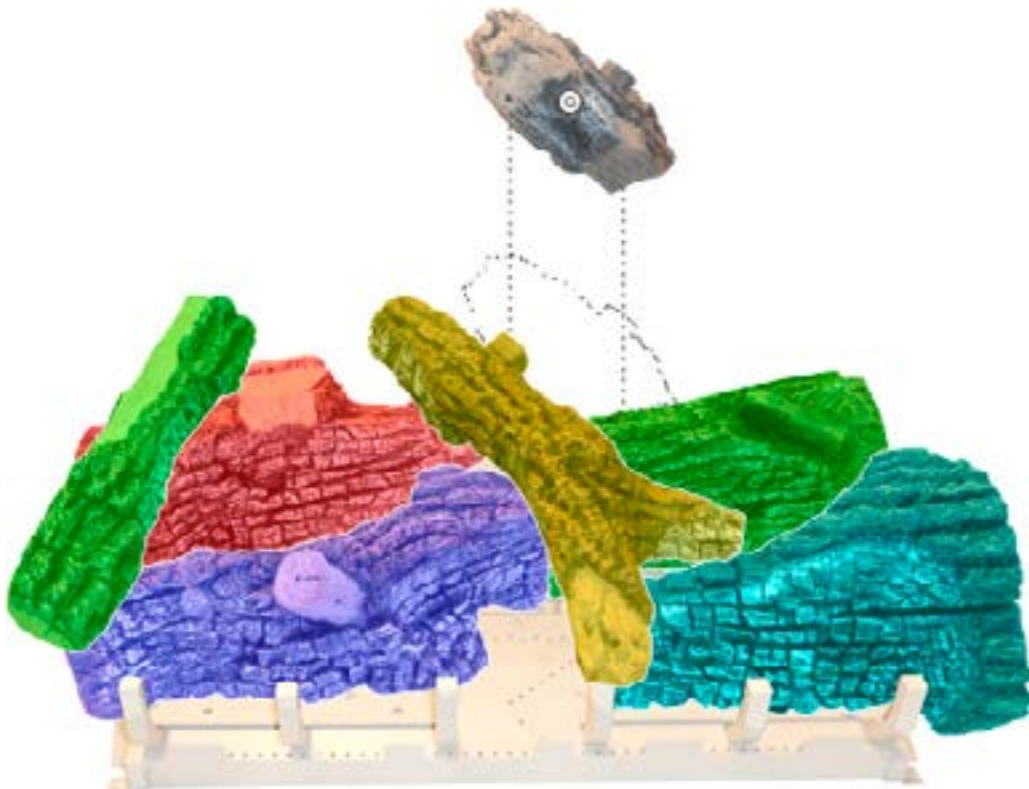

FRONT VIEW

LOG PLACEMENT - STANDARD MODELS

8. Place Log H onto the boss on Log B as shown below.



TOP VIEW

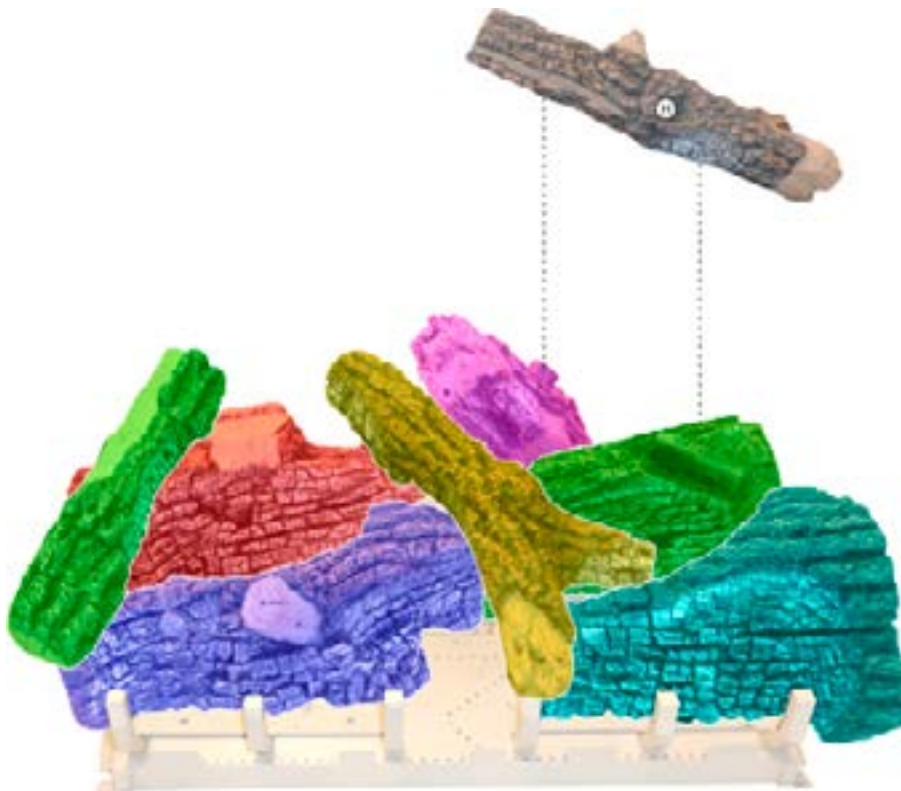



FRONT VIEW

LOG PLACEMENT - STANDARD MODELS

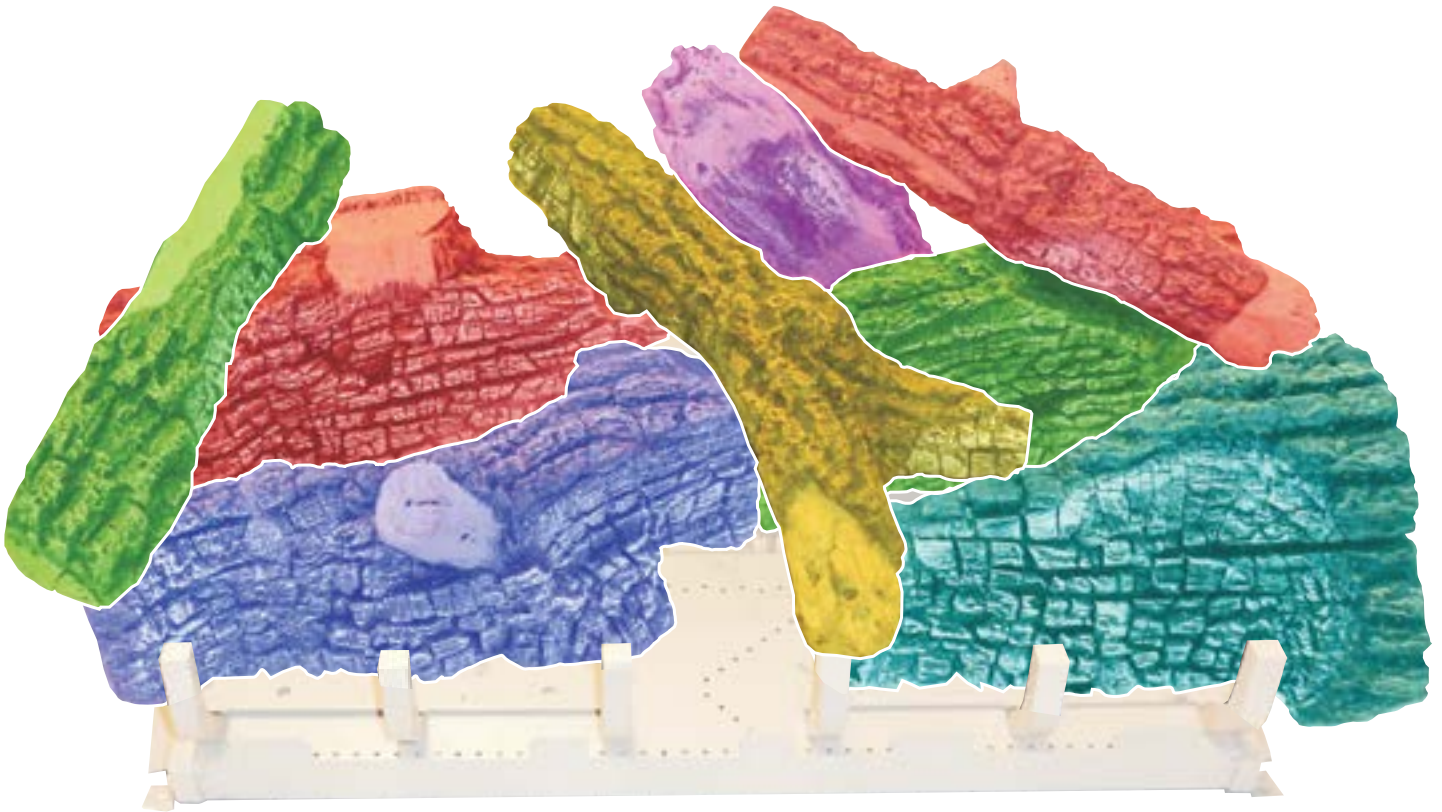
9. Log assembly complete.



LOG IDENTIFICATION - SELECT MODELS

Log Description	Part Number		Front View	Top View
	ALS24RVS	ALS30RVS		
Log A	R11872	R11877		
Log B	R11870	R11875		
Log C	R11871	R11876		
Log D	R11869	R11874		
Log E	R11898	R11898		
Log F	R11900	R11900		
Log G	R11901	R11901		
Log H	R11899	R11890		
Log I	R11897	R11897		

Note: Logs are not shown to scale.

Note: Logs may differ from those shown.

USE ONLY MANUFACTURER'S REPLACEMENT PARTS. USE OF ANY OTHER PARTS COULD CAUSE INJURY OR DEATH.

LOG PLACEMENT - SELECT MODELS

Before you begin: Do not, handle these logs with your bare hands! Always wear gloves to prevent skin irritation. After handling logs, wash your hands gently with soap and water.

All Logs

The positioning of the logs is critical to the safe and clean operation of this heater. Sooting and other problems may result if the logs are not properly and firmly positioned in the appliance.

Refer to Figure 2 for the following warning.

⚠ WARNING

Failure to position the parts in accordance with this diagram or failure to use only parts specifically approved with this appliance may result in property damage or personal injury.

Attention: Do not use Figures 1 to order replacement logs. Refer to Page 16, Log Identification-Select Models, to order logs for your appropriate model number.

The following WARNING applies when log set is installed onto an unvented gas burner assembly.

⚠ WARNING

This appliance is equipped for (natural or propane) gas. Field conversion is not permitted.

Log Placement Select Models

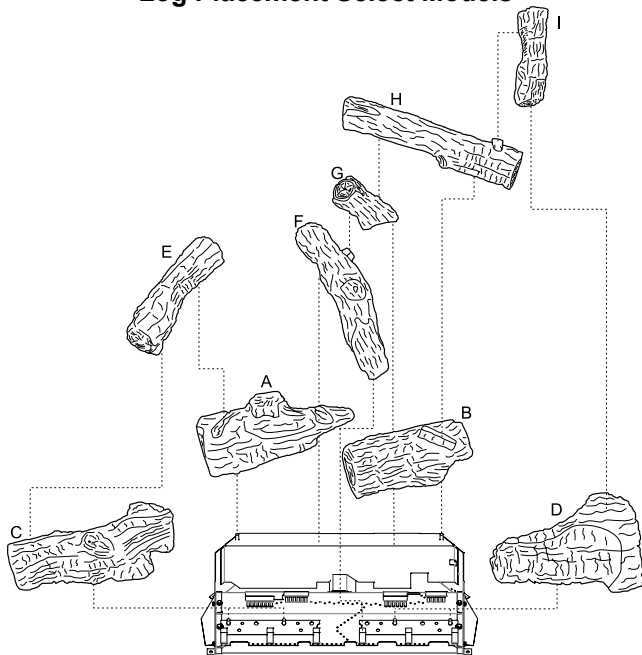

Figure 2

LOG PLACEMENT - SELECT MODELS

1. Place Log A onto rear left burner pin as shown below.



TOP VIEW

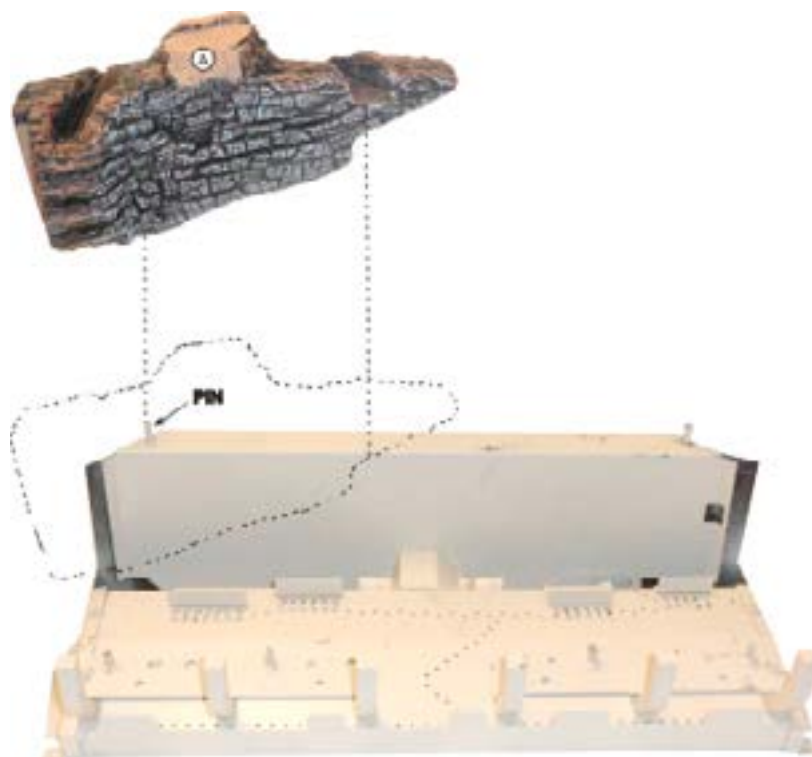

FRONT VIEW

LOG PLACEMENT - SELECT MODELS

- Place Log B onto right rear burner pin as shown below.

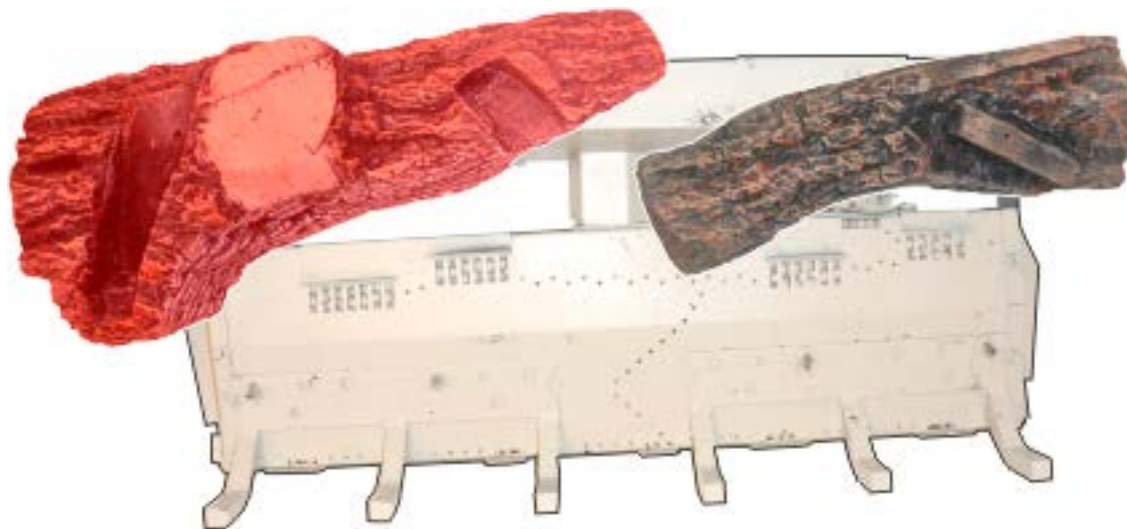

TOP VIEW

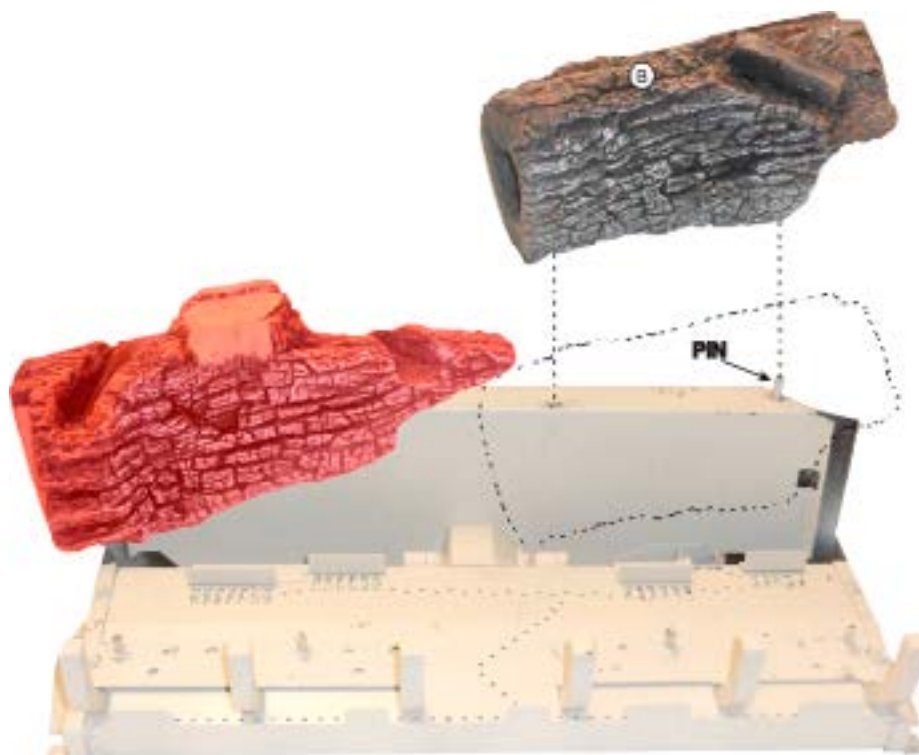

FRONT VIEW

LOG PLACEMENT - SELECT MODELS

3. Place boss of Log C into the hole in Log B and onto the front two left burner pins. See image below.

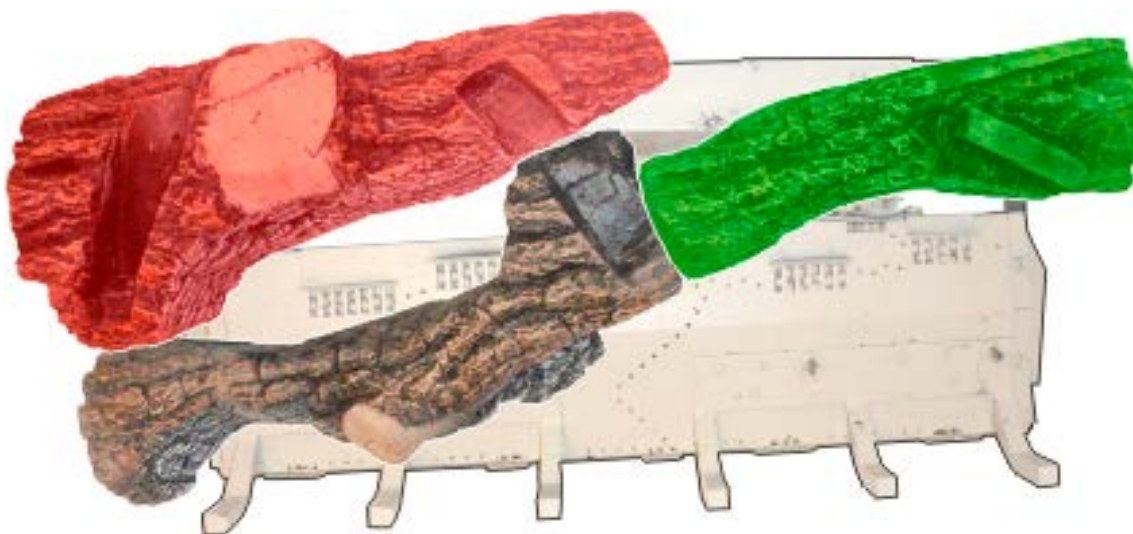

TOP VIEW

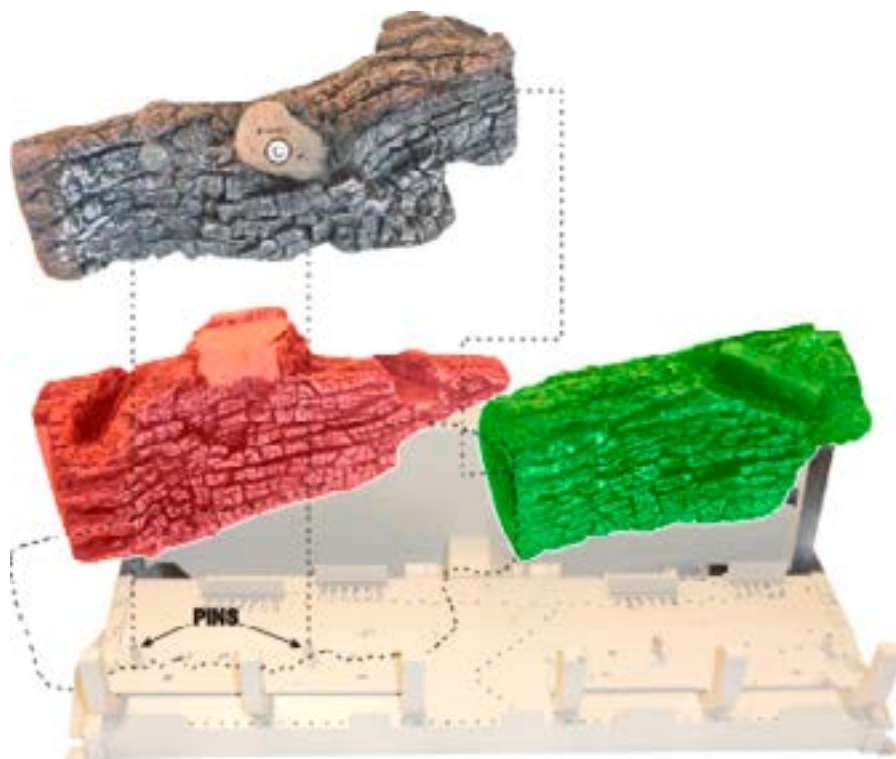

FRONT VIEW

LOG PLACEMENT - SELECT MODELS

- Place Log D onto the front two right burner pins as shown below.



TOP VIEW

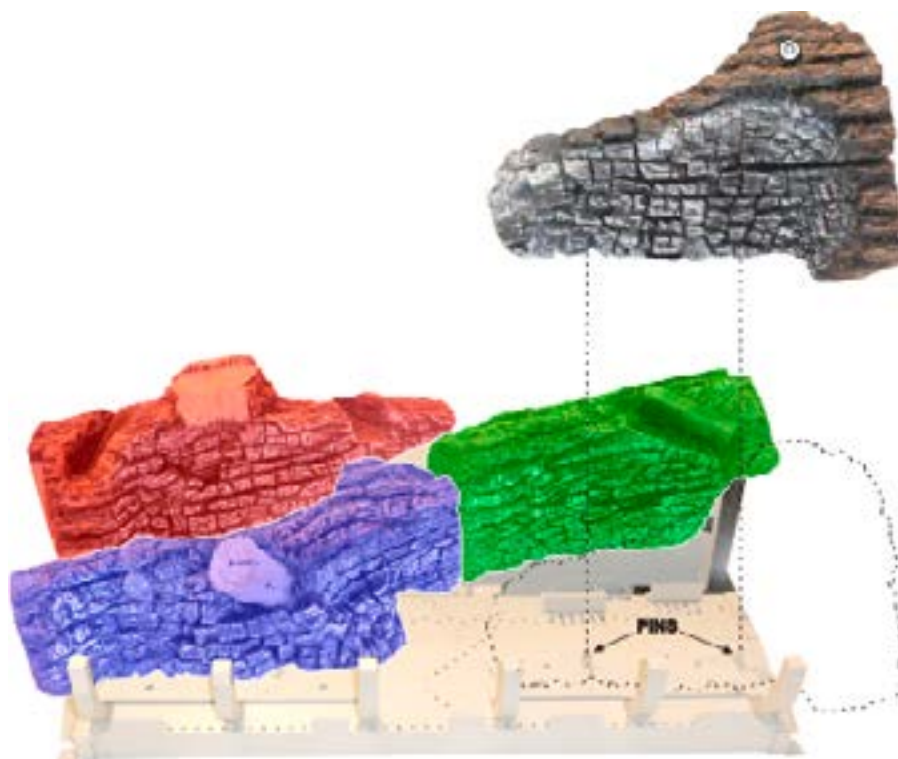

FRONT VIEW

LOG PLACEMENT - SELECT MODELS

5. Place Log E into the left slot in Log A as shown below.



TOP VIEW

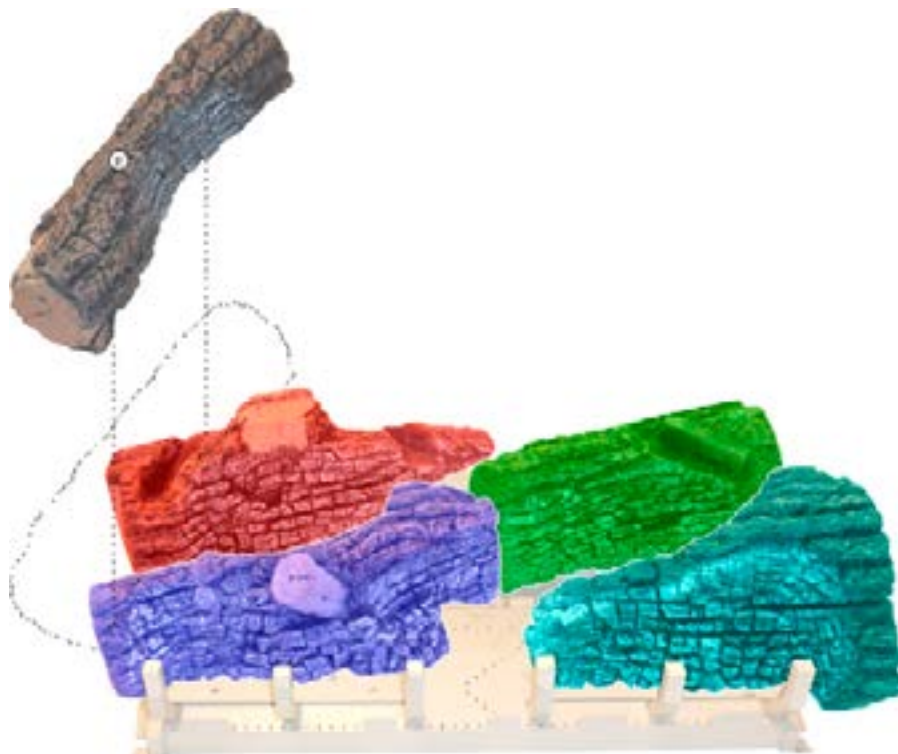

FRONT VIEW

LOG PLACEMENT - SELECT MODELS

6. Place Log F into slot created by Log A and Log C. See image below.

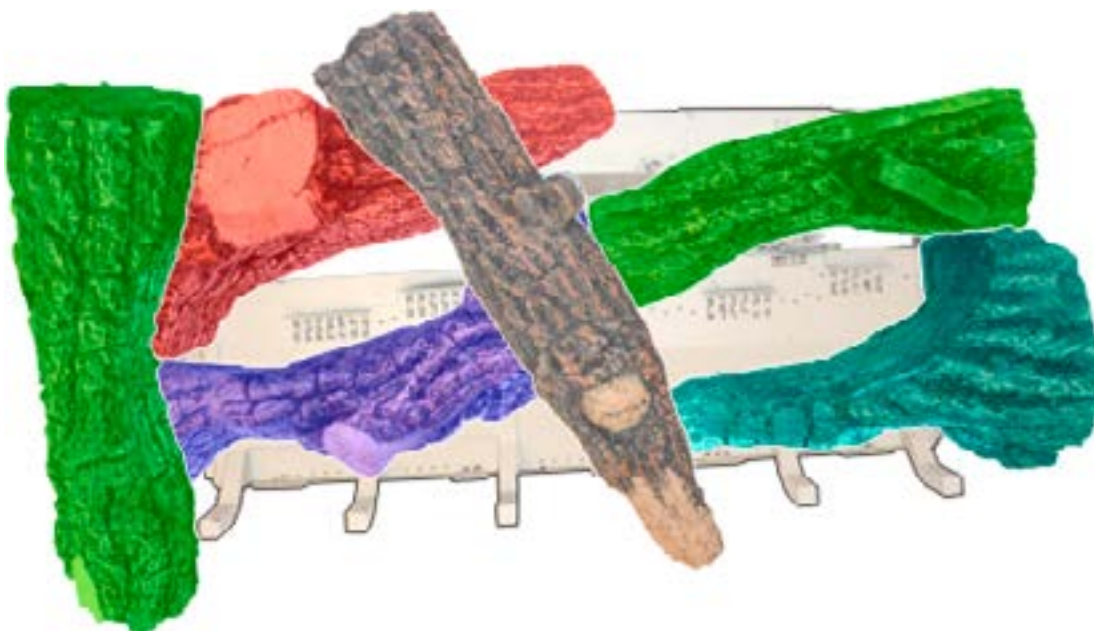

TOP VIEW

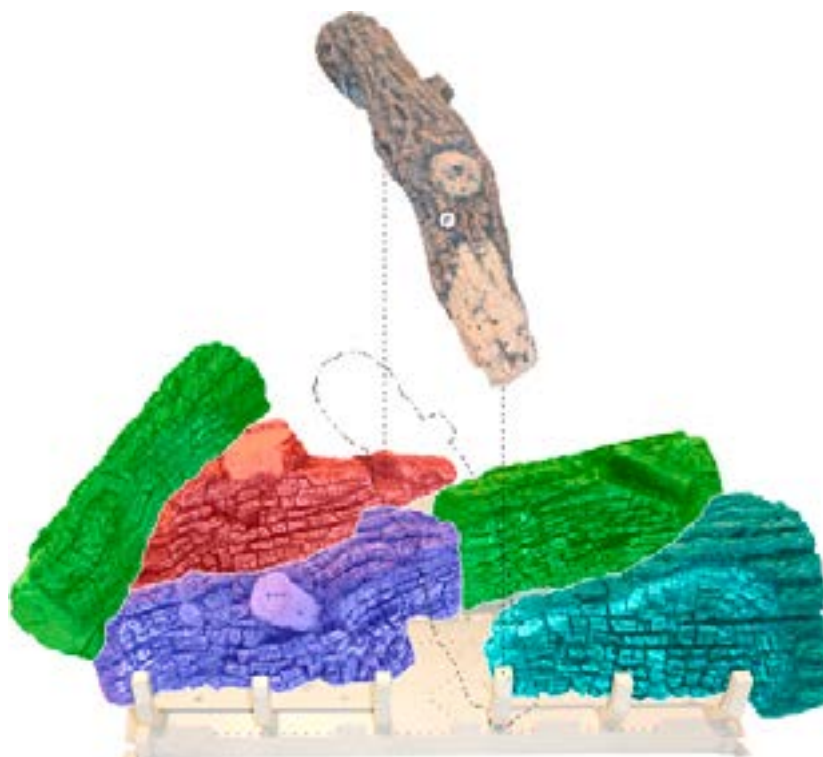

FRONT VIEW

LOG PLACEMENT - SELECT MODELS

7. Place Log G onto boss on Log F and rest on log shelf. See image below.

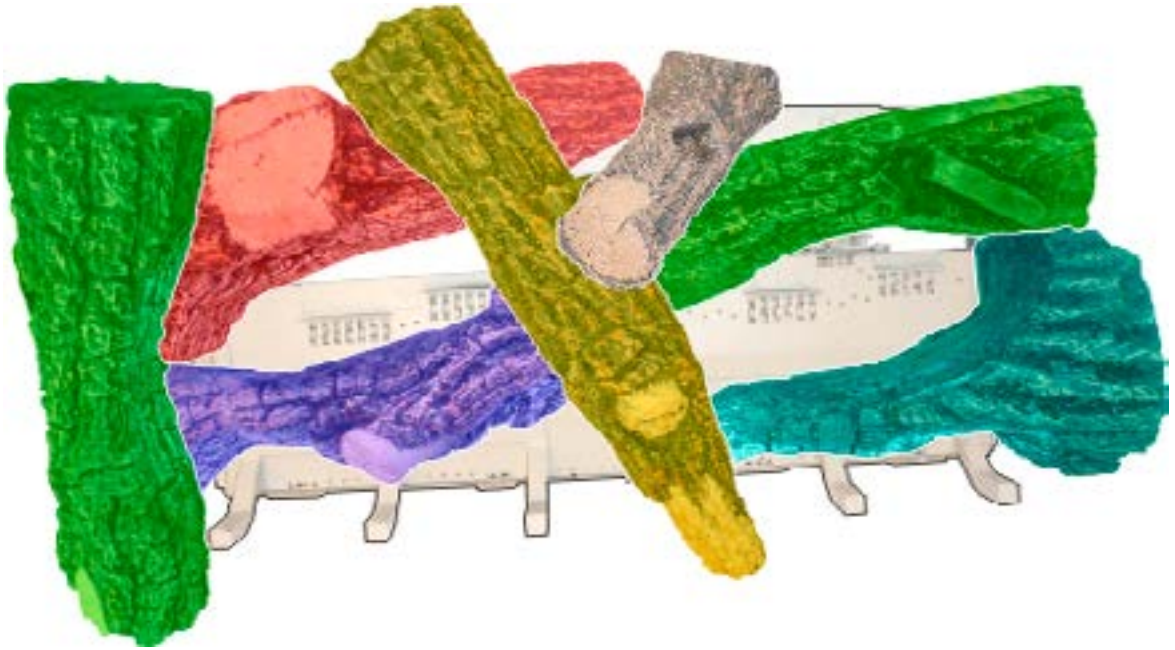

TOP VIEW

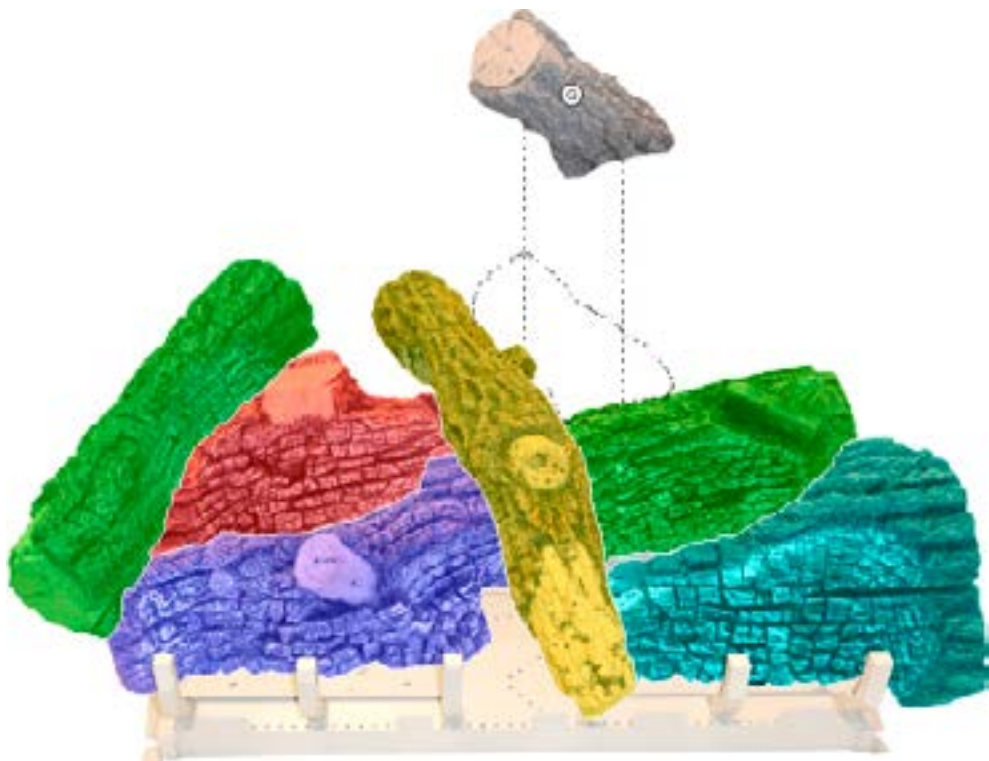

FRONT VIEW

LOG PLACEMENT - SELECT MODELS

8. Place Log H onto the boss on Log B as shown below.

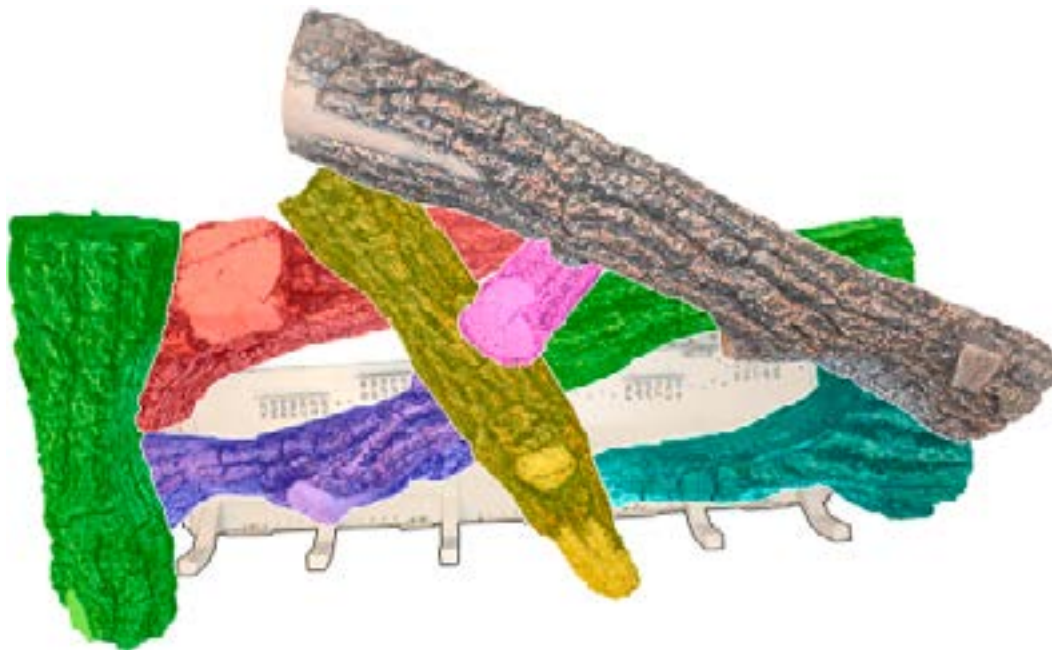

TOP VIEW

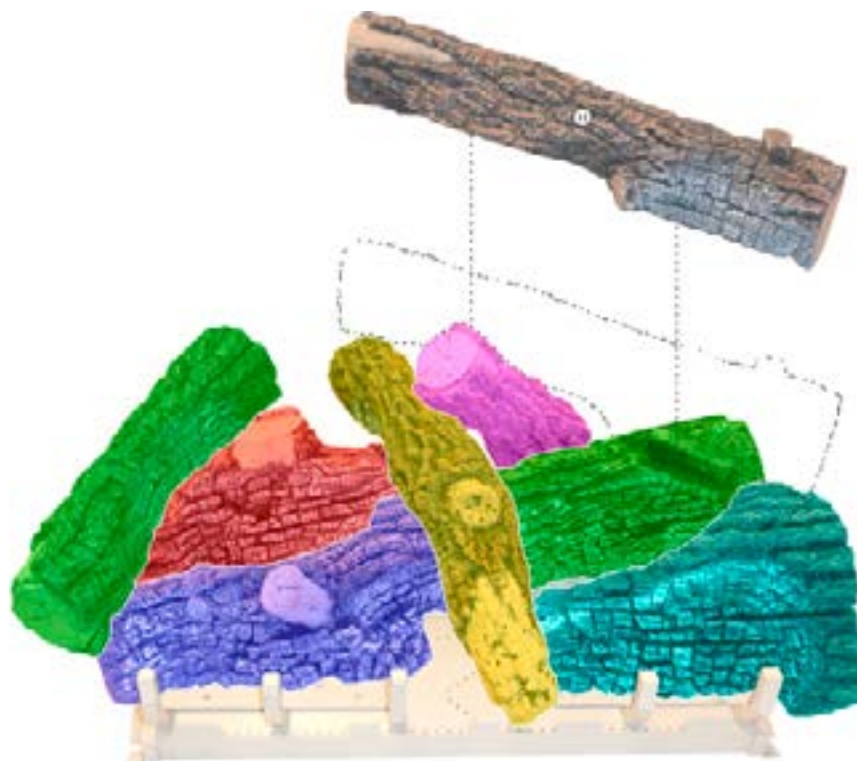

FRONT VIEW

LOG PLACEMENT - SELECT MODELS

9. Place Log I onto the boss on Log H and rest on Log D. See image below.

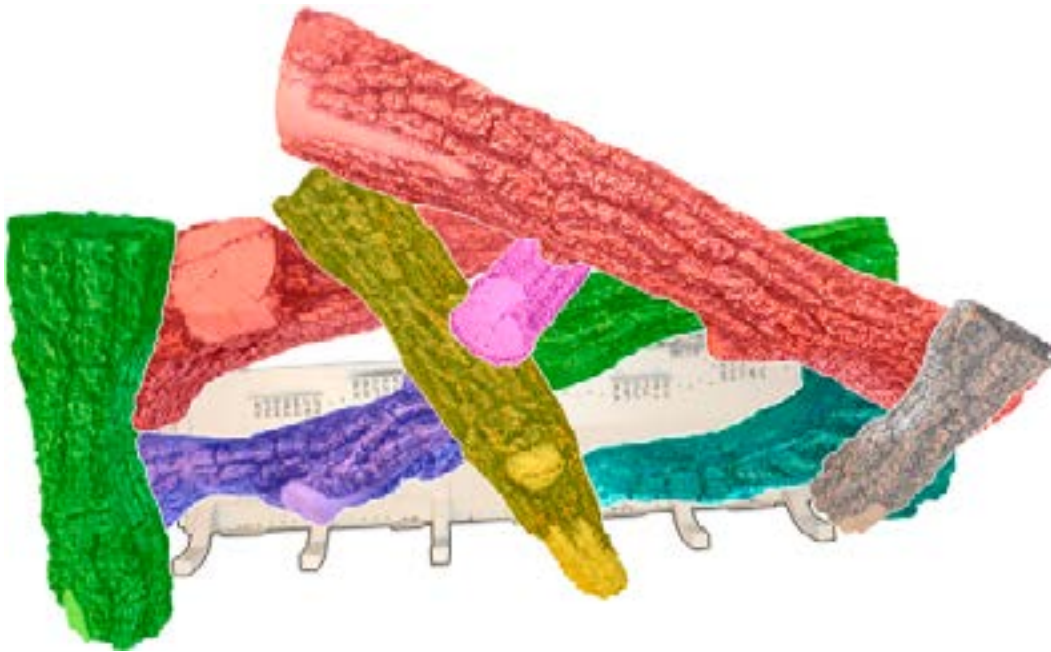

TOP VIEW

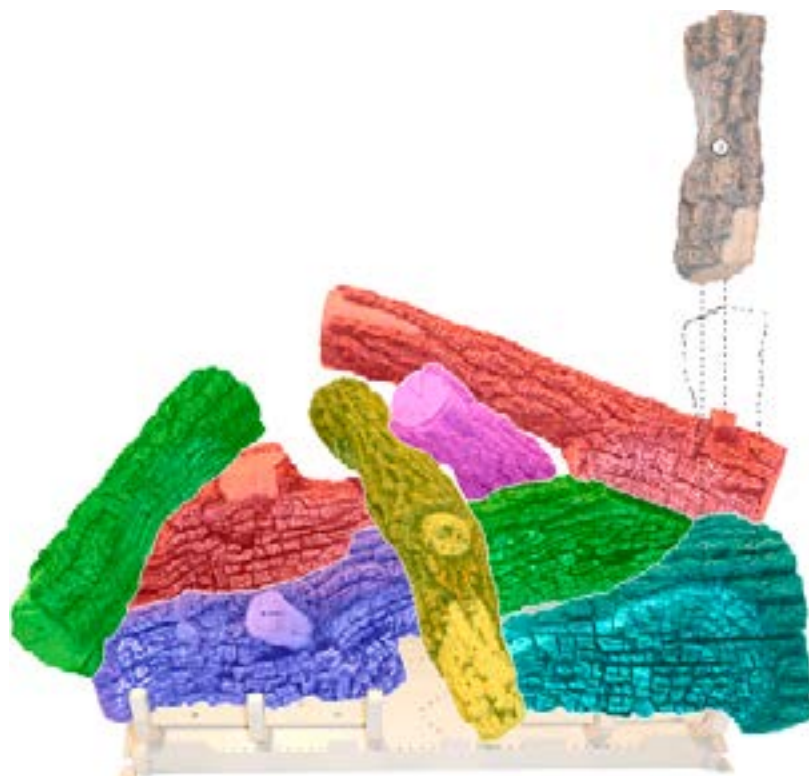

FRONT VIEW

LOG PLACEMENT - SELECT MODELS

10. Log assembly is completed.

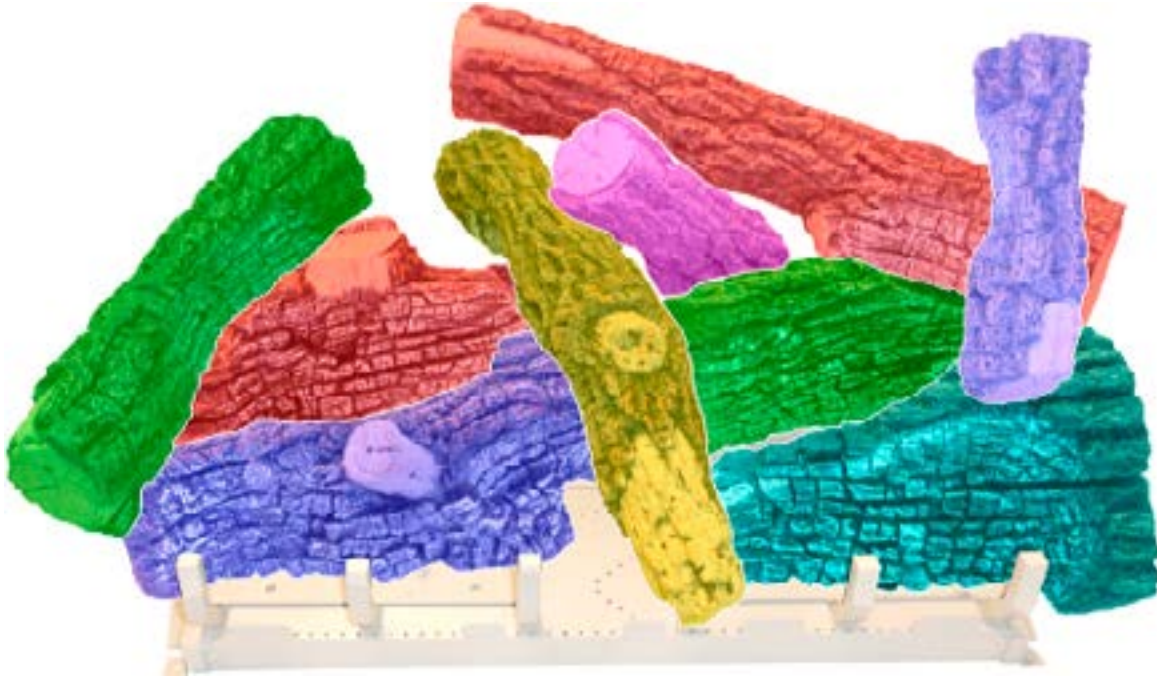

EMBER PLACEMENT

Apply loose material (glowing embers) per appropriate Installation Instructions and Owner's Manual. Replacement of loose material (glowing embers) must be purchased from Empire Comfort Systems, Inc. Application of excess loose material (glowing embers) may adversely affect performance of the heater.

WARNING: All previously applied loose material must be removed prior to reapplication. Replacement Loose Material (glowing embers) Part Number

Note: A single layer of embers is to be used when applying Platinum Bright Embers (alone or in combination with production embers) to the burner.

Photo 1

Do not cover any large rear ports with loose material (glowing embers).

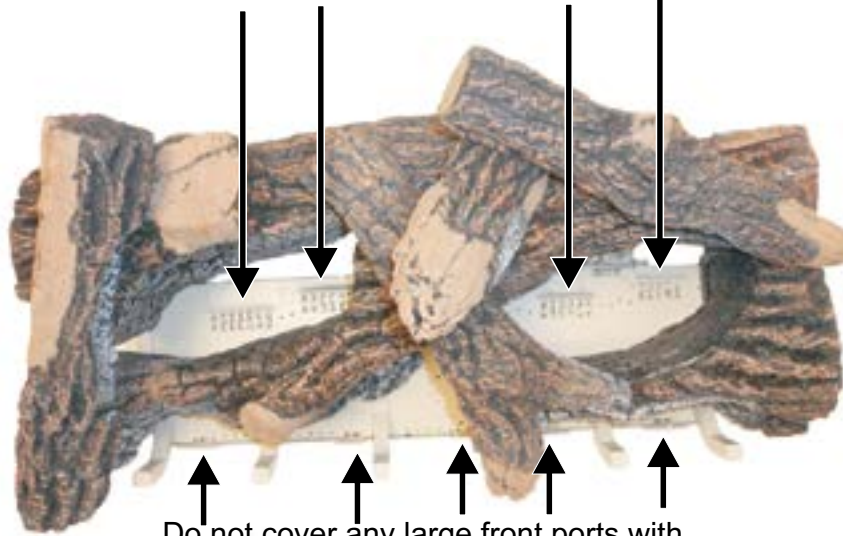

Do not cover any large front ports with loose material (glowing embers).

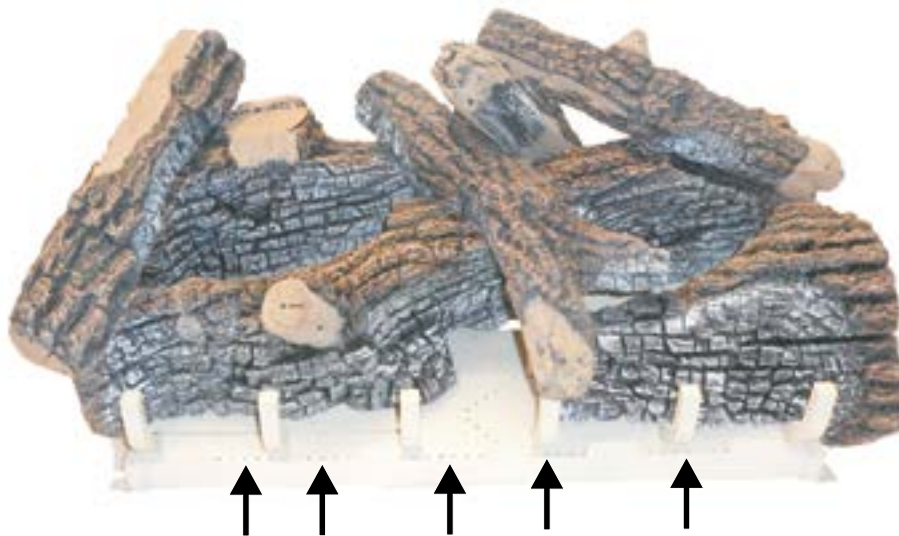

Area for glowing Embers

Photo 2

MASTER PARTS DISTRIBUTOR LIST

To Order Parts Under Warranty, please contact your local Empire dealer. See the dealer locator at www.empirecomfort.com. To provide warranty service, your dealer will need your name and address, purchase date and serial number, and the nature of the problem with the unit.

To Order Parts After the Warranty Period, please contact your dealer or one of the Master Parts Distributors listed below. This list changes from time to time. For the current list, please click on the Master Parts button at www.empirecomfort.com. Please note: Master Parts Distributors are independent businesses that stock the most commonly ordered Original Equipment repair parts for Heaters, Grills, and Fireplaces manufactured by Empire Comfort Systems Inc.

Dey Distributing

1401 Willow Lake Boulevard
Vadnais Heights, MN 55101

Phone: 651-490-9191

Toll Free: 800-397-1339

Website: www.deydistributing.com

Parts: Heater, Hearth and Grills

Victor Division of F. W. Webb Company

200 Locust Street
Hartford, CT 06114

Phone: 860-722-2433

Toll Free: 800-243-9360

Fax: 860-293-0479

Toll Free Fax: 800-274-2004

Websites: www.fwwebb.com & www.victormfg.com

Parts: Heater, Hearth and Grills

East Coast Energy Products

10 East Route 36
West Long Branch, NJ 07764

Phone: 732-870-8809

Toll Free: 800-755-8809

Fax: 732-870-8811

Website: www.eastcoastenergy.com

Parts: Heater, Hearth and Grills

HOW TO ORDER REPAIR PARTS

Parts Not Under Warranty

Parts can be ordered through your Service Person, Dealer, or a Master Parts Distributor. See this page for the Master Parts Distributors list. For best results, the **service person or dealer** should order parts through the distributor. Parts can be shipped directly to the **service person/dealer**.

Warranty Parts

Warranty parts will need a proof of purchase and can be ordered by your Service Person or Dealer. Proof of purchase is **required** for warranty parts.

All parts listed in the Parts List have a Part Number. When ordering parts, first obtain the Model Number and Serial Number from the name plate on your equipment. Then determine the Part Number (**not** the Index Number) and the Description of each part from the following illustration and part list. Be sure to give all this information . . .

Appliance Model Number _____ Part Description _____

Appliance Serial Number _____ Part Number _____

Type of Gas (Propane or Natural) _____

Do not order bolts, screws, washers or nuts. They are standard hardware items and can be purchased at any local hardware store.

Shipments contingent upon strikes, fires and all causes beyond our control.

FIREPLACE SERVICE HISTORY

Date	Dealer Name	Service Technician Name	Service Performed/Notes

FIREPLACE SERVICE HISTORY

Date	Dealer Name	Service Technician Name	Service Performed/Notes



A Registered Trademark of Empire Comfort Systems Inc.
918 Freeburg Ave. Belleville, IL 62220

If you have a general question about our products, please e-mail us at
info@empirecomfort.com.

If you have a service or repair question, please contact your dealer.

www.americanhearth.com