



GAS CONVERSION INSTRUCTIONS

DIRECT-VENT GAS FIREPLACE

CONVERSION KITS	
Model	Part No.
DVCT40CBP95-(1,2)	36884

FOR CONVERSION TO PROPANE GAS

⚠ WARNING

This conversion kit is to be installed by an Empire Comfort Systems, Inc., distributor (or other qualified agency¹)* in accordance with the manufacturer’s instructions and all codes and requirements of the authority having jurisdiction. Failure to follow instructions could result in serious injury or property damage. The qualified agency performing this work assumes responsibility for this conversion.

¹ National Fuel Gas Code Z223.1 (Latest Edition)

***The term “qualified agency” means any individual, firm, corporation or company which either in person or through a representative is engaged in and is responsible for (a) the installation of gas piping or (b) the connection, installation repair, or servicing of equipment, who is experienced in such work, familiar with all precautions required, and has complied with all the requirements of the authority having jurisdiction.**

CHECK THE SAFETY SHUTDOWN PERFORMANCE

⚠ WARNING

Perform the safety shutdown test any time work is done on a gas system to avoid the possibility of fire or explosion with property damage, personal injury or loss of life.

CHECK SAFETY SHUTDOWN SYSTEM

Intermittent Pilot System

1. Turn “OFF” using remote control. Main burner and pilot should go off.
2. Pilot gas flow should stop within 30 seconds.

PARTS LIST		
Part Description	Conversion Kit - 36884	Quantity Supplied
Main Burner Orifice, Front	P287	1
Main Burner Orifice, Rear	P258	1
SIT Gas Valve Conversion Kit	R11382	1
Gas Conversion Label	1224	1

Tools Needed: Standard Screwdriver, 1/4 Inch Hex Driver, 5/16 Inch Hex Driver, 7/16 Inch Wrench, and 7/16 Inch Deep Socket Set

Gas input for direct vent fireplace converted to Propane Gas: DVCT40CBP95 - 45,000 BTU per hour

The direct-vent gas fireplace when converted to Propane gas will have a manifold pressure of approximately 10.0 inches w.c. (2.49kPa) at the valve outlet with the inlet pressure to the valve from a minimum of 10.8 inches w.c. (2.68kPa) for the purpose of input adjustment to a maximum of 14.0 inches w.c. (3.484kPa).

INSTRUCTIONS FOR CONVERSION

1. If the fireplace is installed, turn OFF gas and electric supply to fireplace before making gas conversion. Allow fireplace to cool completely.
2. Remove barrier screen, glass door, logs and embers, and liners (see Homeowner's Manual and Liner Instructions).

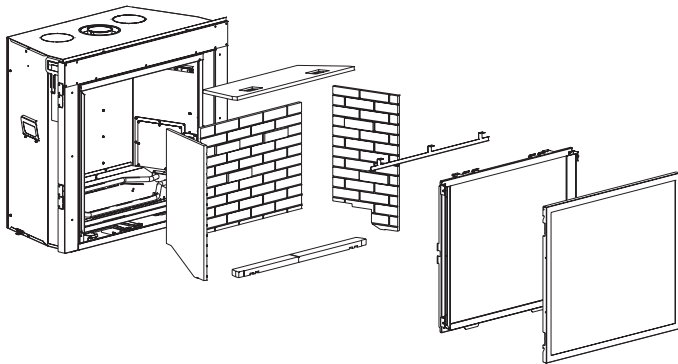

Figure 1

3. Remove front and rear burners by removing screws on left and pulling out towards left side (Figure 2).

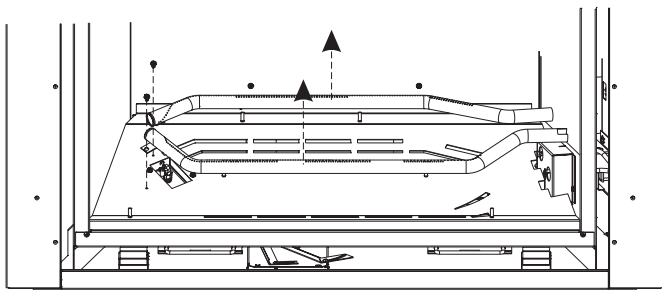

Figure 2

4. Remove (2) screws holding pilot assembly to burner pan. This will allow pilot assembly to drop (Figure 3).

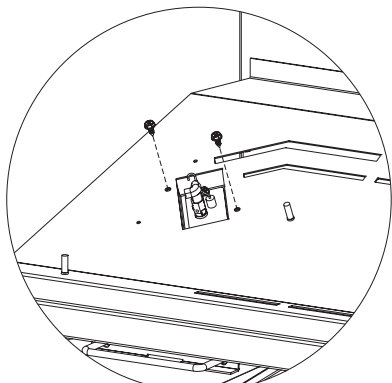

Figure 3

5. Remove (2) screws holding burner base in place. Lift burner base out of firebox. (Figure 4)

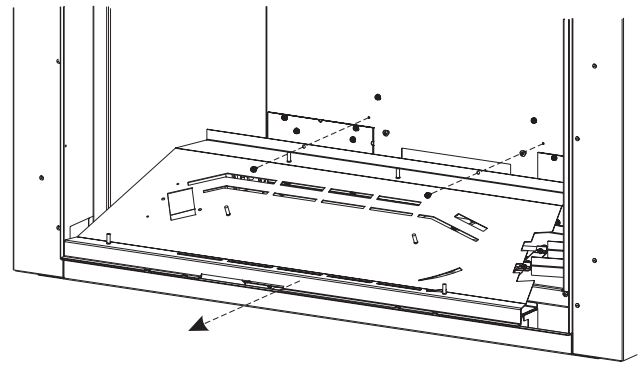

Figure 4

6. Use needle-nose pliers to remove targets and discard. (Figure 5)

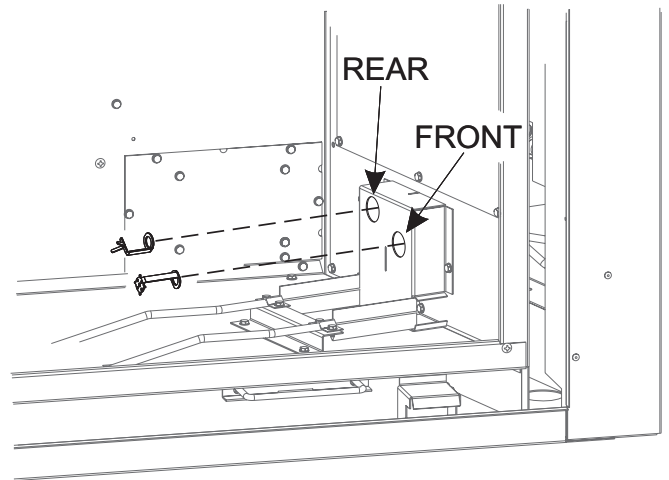

Figure 5

7. Use a 7/16 inch deep socket set to remove front and rear orifices.
8. Use a 7/16 inch deep socket set to install orifice marked "1.45" in rear orifice holder and "#56" in front orifice holder.

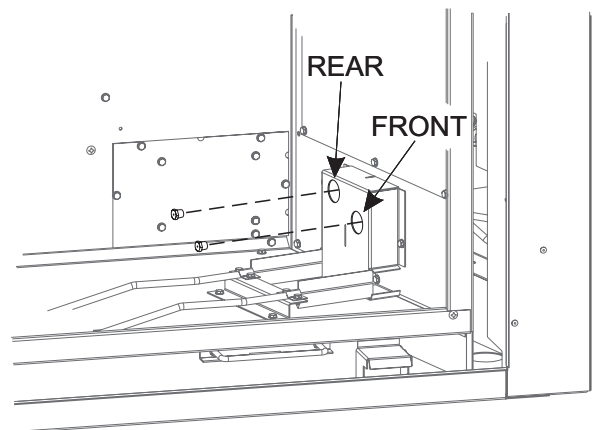

Figure 6

9. Loosen rear air shutter screw and rotate handle to the right until full open is achieved and tighten down screw (**Figure 7**).
10. Repeat with front.

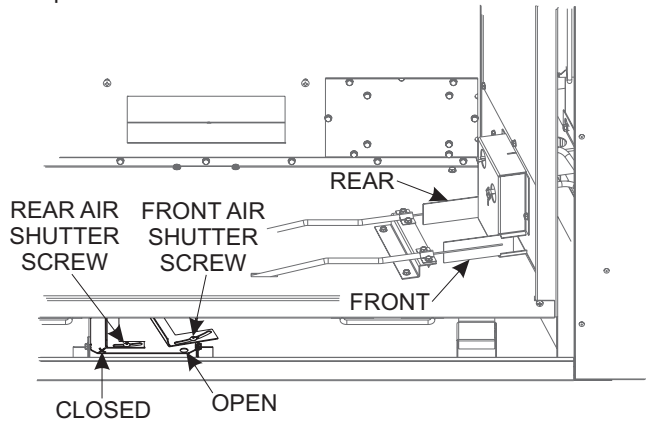

Figure 7

11. Using a 7/16 inch open wrench, loosen pilot body by slightly turning counter-clockwise. Slide orifice bracket to other side and tighten pilot body clockwise (**Figure 8**)

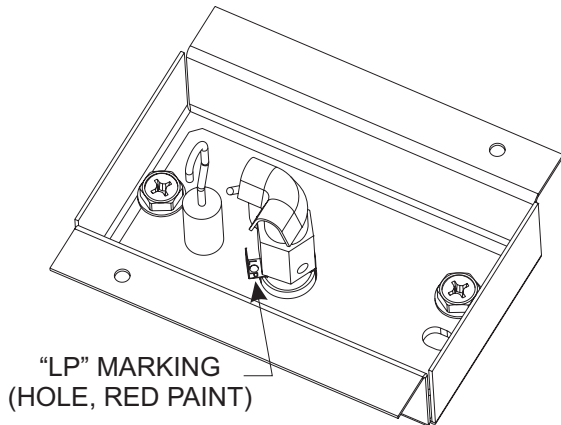

Figure 8

12. Replace items removed in steps 2-5 in reverse order.
13. Gas conversion completed.

Check the main burner flame and pilot burner flame for proper flame characteristics, as outlined in the Installation Instructions and Owner's Manual.

Verify Input Rate of Converted Fireplace

Check the input of the fireplace.

1. Turn off all other gas appliances. Clock the gas meter and determine the number of seconds required to consume one cubic foot of gas.
2. $3600 \div \text{time (in seconds)} = \text{cu. Ft. per hour}$.
3. Then $\text{cu. Ft. per hour} \times \text{heating value of gas} = \text{input rate (Btuh)}$. On installation without gas meters, check manifold for proper pressure.

If fireplace is not installed or product registration card has not been returned to Empire Comfort System's, check off type of gas converted to on the card. Also indicate conversion by adding "Conv." behind type of gas.



SINCE 1932

www.empirecomfort.com

Empire Comfort Systems Inc.
Belleville, IL

If you have a general question
about our products, please e-mail
us at info@empirecomfort.com.

If you have a service or repair
question, please contact your dealer.